

Art.no 482-38,482-39

FIRST USE

STEP 1.

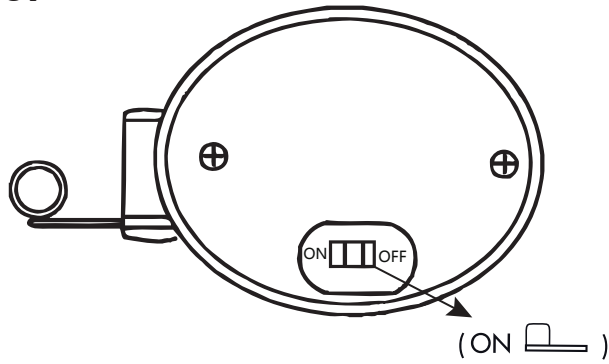

STEP 2.

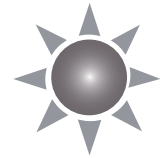

(ON)



(OFF)

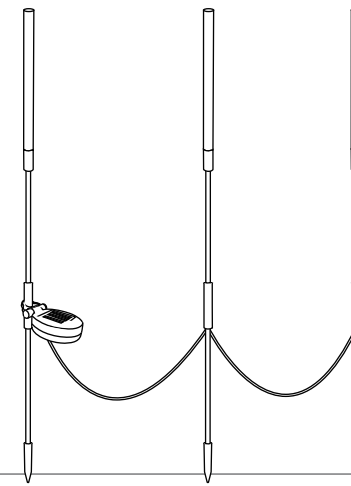

Ready after
36 h in the sun

BATTERY REPLACEMENT

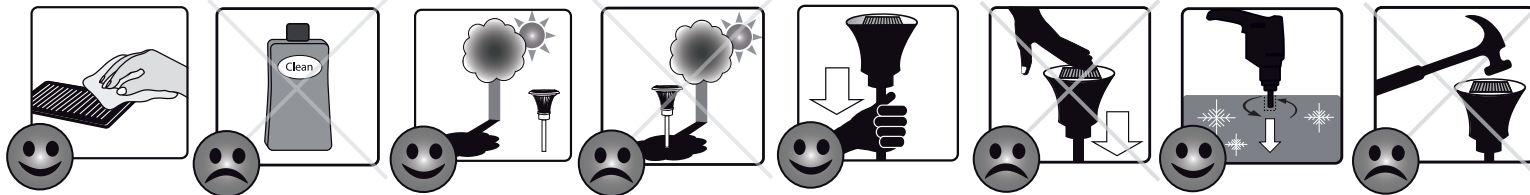
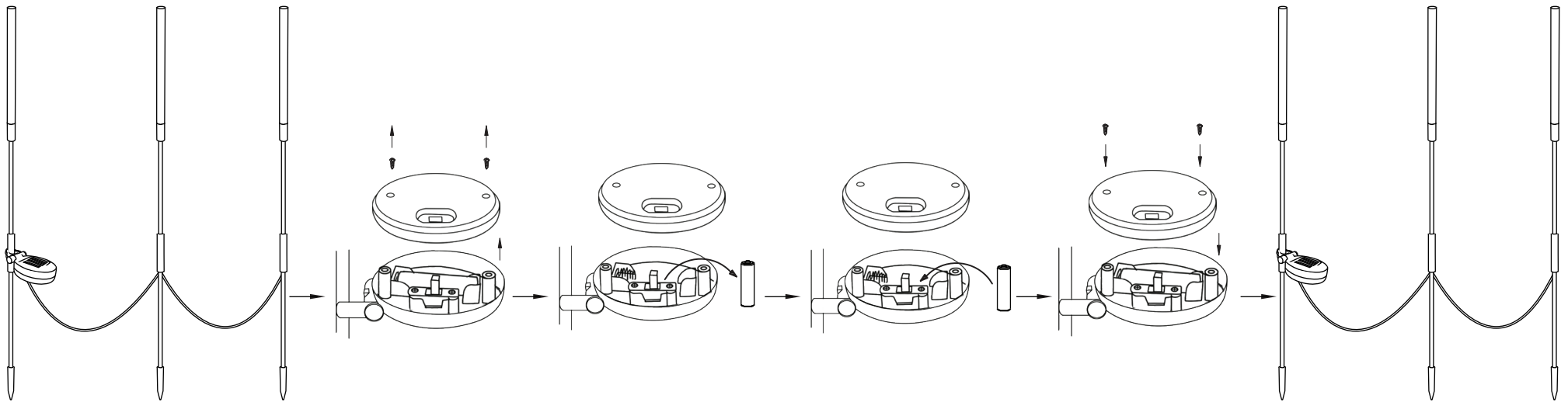

STAR[®]
TRADING
STAR STREET 1
512 50 SVENLJUNGA
SWEDEN
www.startrading.com