

Art.no 482-18

FIRST USE

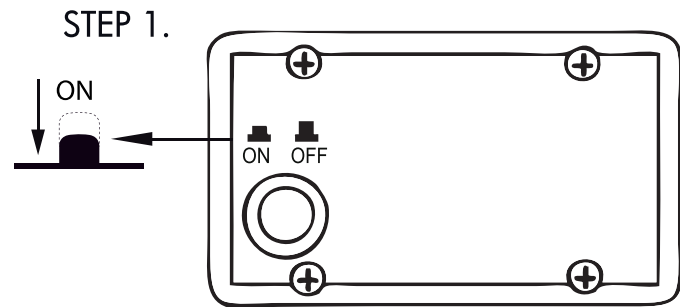

STEP 2.

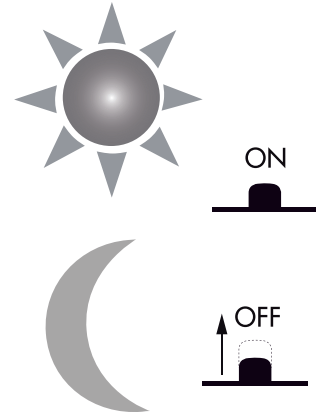

Ready after
36 h in the sun

BATTERY REPLACEMENT

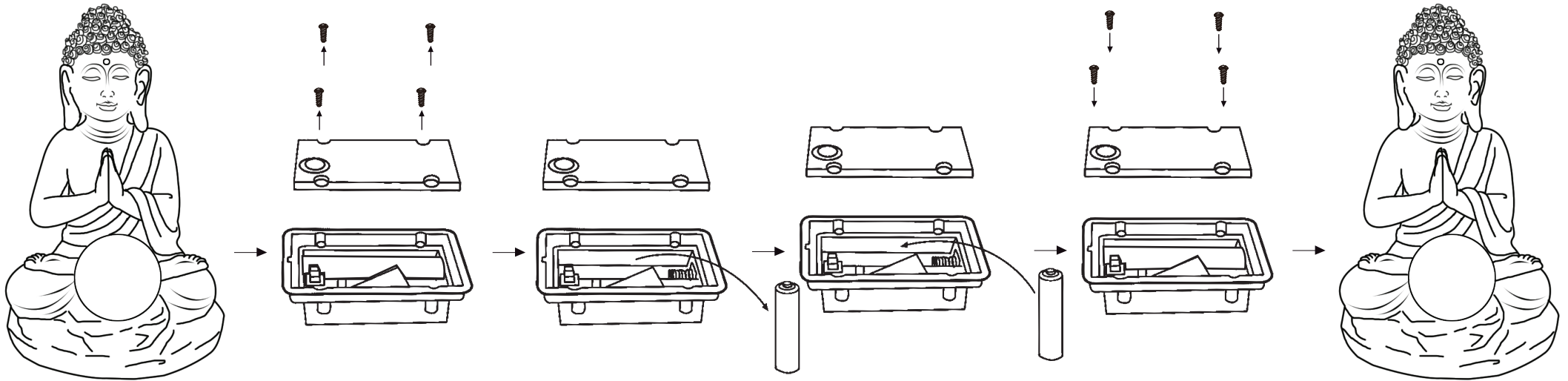

STAR[®]
TRADING
STAR STREET 1
512 50 SVENLJUNGA
SWEDEN
www.startrading.com